

Varenummer: 203260M1060A1S
 Beskrivelse: E+G Justerfod
 GN 32-60-M10-60-A1-S
 Note: S Uden møtrik, udvendig sekskant i bunden

Mål

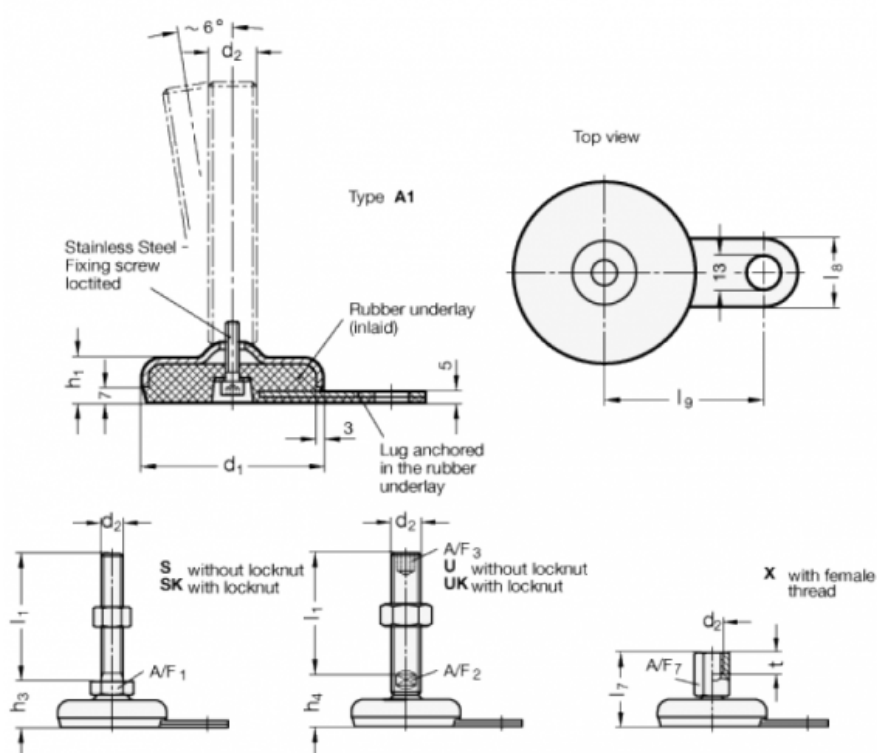

A/F1	=	17
d1	=	60
d2	=	M10
h1	=	19
h3	=	27
l1	=	60
l8	=	25
l9	=	50